

Separett[®]

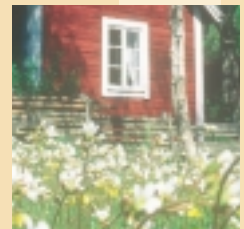

Separett[®] "VILLA" - 5-year guarantee

Waterless Toilets

A complete toilet system for holiday and residential homes

www.separett.com

Separett® "VILLA"

Model 9000/9100



Tiles from Kalkhuset in Jönköping, Sweden

With the new Villa 9000, the standard for environmentally-friendly toilets has been set higher than ever. In terms of design, stability, comfort and use, it is the equal of a modern WC in every way. The built-in, 2-speed fan expels odours and condensation from the toilet and bathroom quietly and effectively. The venting duct can be run straight through an outer wall. The Villa 9000 can be installed in both warm and cold locations, and will work perfectly well irrespective of the room temperature. It can be placed according to your needs and fastened to the wall or floor. The Villa 9000 is supplied complete for simple installation, with a venting pipe (Ø75 mm) to go through a wall and a 2-metre long (Ø32 mm) urine waste hose.

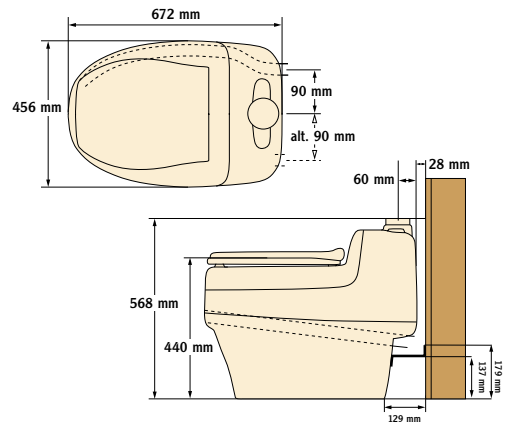

The Separett Villa 9000 is supplied with:

Child seat, venting pipe (40 cm, Ø75 mm) and vent, flashing, 90° pipe joint, cowl, 3 solid waste/compost containers and 2 lids, 10 solid waste bags, 2 m white hose for urine waste (Ø32 mm), silicone sealant compound, mounting screws.

Separett® "CHILD SEAT"

The new Separett child seat with division for liquids and solids is included as a standard with the Separett Villa and Chalet. Along the child seat is a rubber edge that gives it a firm hold against the toilet seat. The high polished propylen surface also makes it easy to clean.



When you sit down, the unique pressure seat opens a view guard that otherwise covers the solid waste container. At the same time, the container is rotated so that the contents are evenly distributed.

To make it easier to direct the urine correctly, the toilet is supplied with an extension that is easy to connect and remove.



waste bags that are placed in the container to simplify cleaning after composting are included. Additional bags can be bought.

Change container: The lid is replaced and the container is lifted out for composting.

The toilet is supplied with 3 containers. Solid



excess amounts of condensation, such as after a shower.

Villa 9100 is a 110V, 19W version of the same toilet with a one speed fan.

Guarantee conditions: Separett's 5-year guarantee includes all materials (not labour) for all original parts in the toilet.

Separett® "VILLA"

Model 9010 12V

For cottages that do not have access to a 230V power supply, the Villa model is available with a 12V fan. The fan (1.9W, 160mA) is highly suitable for battery/solar power. Operating time using a 12V, 75Ah battery is about 2 weeks. Apart from the 12V fan, the 9010 is identical to the Villa 9000. It is also supplied complete for simple installation with a venting pipe to run through a wall and a 2-metre long hose for urine waste.



5-years guarantee



**New Standard:
Child Seat Included**

Technical data	Material, toilet seat	Inner container	Voltage/Wattage	Power consumption	Electrical connection	Noise level fan
Villa 9000	Impact-resistant high-gloss polypropylene, recyclable	23 litres Polypropylene	230V/16,5/11,5W	0,396/0,276 kWh/24 hrs	Lead 1.7 m Earthed plug	41/31 dB(A)
Villa 9010			12V/1,9W/160mA	0,0456 kWh/24 hrs	Battery cable, 1.7 m	<30 dB(A)

5-years guarantee



**New Standard:
Child Seat Included**

Separett® "CHALET"

Model 4210 12/230V

The Chalet 4210 is designed and manufactured to ensure the best possible performance in the smallest of rooms. Total depth only 55 cm. Naturally, the toilet has a urine diverter in front, a view guard in back that slides open when the seat is pressed down

and a manually rotating solid waste container. The Chalet is supplied with an energy-efficient 12V fan (1.9W, 160 mA) that can be fitted on the right or left side, a venting pipe for routing through a wall and a 2-metre long wastewater hose for the urine. Electrical connection either with a 12V battery cable or a 230V power adapter (both included). Operating time using a 12V, 75Ah battery is about 2 weeks.

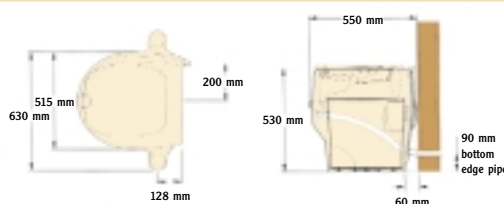

The Chalet 4210 is supplied with:

Child seat, ventilation connector with 12V fan, venting pipe (40 cm, Ø75 mm), flashing, vent, cowl, 2 solid waste/compost containers and 1 lid, 10 solid waste bags, 2 m white hose for urine waste (Ø32 mm), 2 m battery cable, 230V power adapter, silicone sealant compound, mounting screws.

Technical data	Material, toilet seat	Inner container	Voltage/Wattage	Power consumption	Electrical connection	Noise level fan
Chalet 4210	Recyclable high-gloss polystyrene	27 litres Recyclable polythene	12V, 1.9W, 160 mA	0,0456 kWh/24 hrs	Battery cable 2 metres or power adapter 12/230V	<30 dB(A)

Guarantee conditions: Separett's 5-year guarantee includes all materials (not labour) for all original parts in the toilet.

Separett® "CLASSIC"

Model 3000

The environmentally-friendly Separett Classic toilet has been a familiar feature in many dwellings since 1976 and is still a very convenient alternative for locations where it is not possible to install a sewer. Using heat and ventilation, Classic evaporates urine and dehydrates solids, thereby minimising the waste volume. When the container is full, it is simply lifted out and the contents composted. Classic is supplied with 2 containers. This is normally sufficient, when the containers are used alternately, for about 4 people in a holiday home. The fan keeps the room free from both odours and moisture, while a carbon filter removes urine odour from the expelled air. Classic must be placed in a room with a minimum temperature of 18°C, a vent must be fitted in an outer wall and a lagged venting pipe must be routed through the roof. The child seat is obtained as an accessory (Item no. 1101-01)

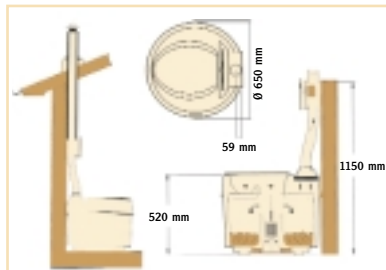

The Classic 3000 is supplied with:
Venting pipe cowl, 2 solid waste/compost containers with double urine discs and 1 lid, carbon filter cassette.



Technical data	Material, toilet seat	Inner container	Voltage/Wattage	Power consumption	Electrical connection	Noise level fan
Classic 3000	Noryl	43 litres Noryl	230V/325W, fan 19W, flush motor 55W, heating element 250W	3,5-5 kWh/24 hrs	Lead 1.8m Earthed plug	40 dB(A)

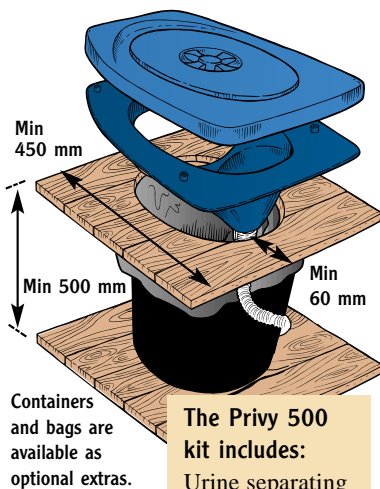

Containers and bags are available as optional extras.

The Privy 500 kit includes:
Urine separating kit, insulated seat, 2.5 m hose for urine waste.

Separett® "PRIVY"

Model 500

The Separett Privy is a urine-diverter kit that can be easily fitted in an existing outdoor toilet. Urine and solids are kept separate, latrine-type odours disappear and the substantially reduced waste is easy to deal with. The urine is routed via a hose to a soakaway or tank. Containers and bags for solids and paper are available as optional extras. Included in the kit is the Insulated Seat 300, which ensures comfortable year-round use.

Separett® "INSULATED SEAT"

Model 300

Placed on the seat in an outdoor toilet. Extra durable, 30 mm thick. Made from cellular plastic.

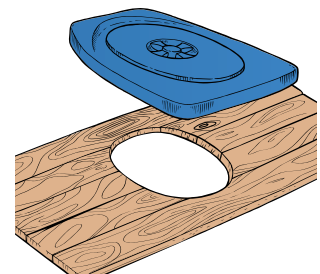

Separett® "EJECTORTANK"

Model 50

The Separett Ejectortank is easy to install, has no moving parts and automatically mixes (in the ejector) 8 parts water to 1 part urine. Access to water with a minimum pressure of 2 kp/cm² is required. The 50-litre tank is sufficient for holiday homes, when emptied every second or third week. A float indicates when the tank is full. The Ejectortank mixes urine and water and is emptied and cleaned automatically without the need for user intervention. The Ejectortank connects to a 3/4" garden hose. A 10-metre long, 3/4" emptying hose with a 50 cm nozzle is included. (The hose can be extended to 20 metres.)

The Ejectortank includes the following:

Container (50 litres), lid with ejector 8:1, float, 10 metre 3/4" hose with nozzle.

Height 610 mm, diameter 465 mm.

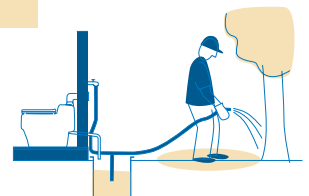

Guarantee conditions: Separett's 5-year guarantee includes all materials (not labour) for all original parts in the toilet.

Accessories

Spare solid waste container including lid
For Villa 9000 Item no. 1098-02
For Chalet 4210 and earlier models 4000- 6200 Item no. 1035-01

Child seat (1,2)
Item no.1101-01, see information on page 2

Solid waste bag (1,2)
(10 per roll) for Villa 9000 Item no. 1099-01
For Chalet 4210 and earlier models 4000-6200 Item no. 1037-01
For Compact Item no. 1038-01

Waterseal urine waste pipe
Ø32-40mm
NB! Only needs to be fitted if an unpleasant odour from the domestic wastewater system flows up through the toilet and can be smelt outdoors. T-pipe (Ø32-40 mm), U-bend pipe, 2 wall mounts, glue sealant. Item no. 1032-02

Separett Absorb
Compostable
Absorbs any moist in the solid waste container, at use or during the composting. (5 pieces of Absorb tissues/package) Item no.1060-01

Venting pipe, 2 metres
White, Ø75 mm
2 metre pipe, 2 wall mounts
Item no. 1020-03

Sleeve couplings, EPDM rubber
Tarred roof/Tiled roof
Item no. 1092-01

Venting pipe cowl
Ø75mm (1,2)
Item no. 1030-01

Insulation for venting pipe
Ø75mm
2 metres, for Classic and Chalet
Item no. 1019-02

Connector pipe, straight
Ø75mm (1,2)
Item no. 1023-01

Sealant ring
Small pipe coupling Ø75-55 mm Item no. 1024-01
Large pipe coupling Ø75-110 mm Item no. 1025-01

Connector pipe 90°
Ø75mm (1,2)
Item no. 1021-01

Flashing (1,2)
Ø75mm
Item no. 1027-02

Grill for venting pipe (1,2)
Ø75mm
Item no. 1026-02

Ejectortank 50 l
Item no.1013-02, See information on page 4

(1) Included with Villa
(2) Included with Chalet

Accessories Classic

Carbon replacement For carbon filter, Classic Item no. 1040-01	Carbon filter Komplett, replacement For Classic Item no. 1039-01	Solid waste container Incl. 2 urine discs and lid For Classic Item no. 1036-01
--	--	--

Installation

There are no temperature range restrictions for rooms where the Villa and Chalet toilets are to be installed. The toilets will function in both warm and cold locations. It must be possible to route the urine away and mount a venting pipe. Access to 230V, 110V, or 12V depending on model.

Chalet (with 12V fans) we recommend a maximum of two 90° pipe joints according to options 1, 2 or 3. If there is already a venting pipe, the toilets can be connected to this. The Villa 9000 and 9010 are fitted with condensation collectors and the venting pipe does not need insulation. With Chalet, we recommend insulation of the pipe if it runs through a cold area.

Venting

The venting pipe can be routed through a wall or the roof. The Villa 9000, with 230V fan, can be installed without any restrictions as to length or the number of pipe joints. For example, up into a cold loft and out through a suitable side of the building. For Villa 9010 and

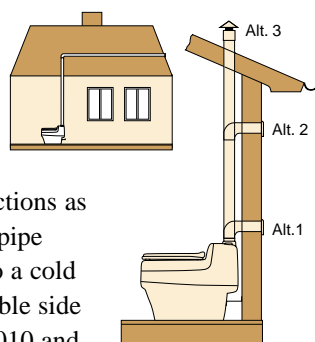

Urine waste pipe

The urine drainage pipe can be led to a domestic wastewater pipe (e.g. sink or shower), a soakaway or a tank. Details concerning the most suitable and approved alternative can be obtained from your local environmental and health authorities.

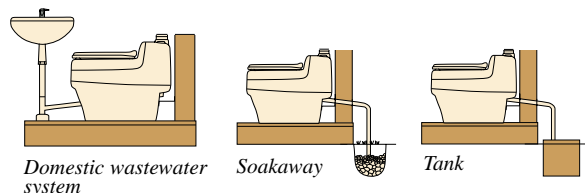

Separett – a complete toilet system for holiday and residential homes

The first Separett toilet was manufactured more than 25 years ago. Continual developments of the technical and design aspects of our products have made them more current than ever. Designed to meet consumer demands for comfort and the authorities' requirements concerning environmental controls.

This is how we overcome unpleasant odours – and protect the environment

Until now, waterless toilets have entailed unpleasant odours. When urine and faeces become mixed together, the combination starts to ferment. Ammonia and hydrogen sulphide are produced and the result is a pungent latrine-type odour that has to be vented away. Until now, it has been necessary to route the ventilation duct up through the roof in order to reduce the odour outdoors.

In Separett toilets, we never mix

Here, liquid and solid waste are routed separately. The urine is led via a waste pipe into the domestic wastewater system, to a sand bed soakaway or a tank where it is collected and used later on as fertiliser. Keeping the urine separate means that it cannot cause any unpleasant odours. The solid waste, faeces and toilet paper are routed into the container inside the toilet. After a while, the surface of the faeces becomes dry. Then the odour from the solid waste more or less disappears too. The energy-efficient, built-in fan keeps the toilet or shower area free from odours and moisture, and the separation of liquid and solids means that odours outdoors are kept at bay too. In practice, it is therefore sufficient just to have the venting pipe through a rear wall or gable. Capacity is also very high. The urine, which accounts for about 85% of the volume, is removed and the remainder, along with the paper, that is stored in the container is easily lifted out and composted.

Easy to deal with

Composting

The inner container is lifted out and placed in a suitable location in the garden. Soil is added and the lid replaced, but with a slight opening that allows the compost to vent. For health and safety reasons, the minimum time the contents must be left to compost is six (6) months. The contents, which make an excellent soil improver, are then tilled into the garden.

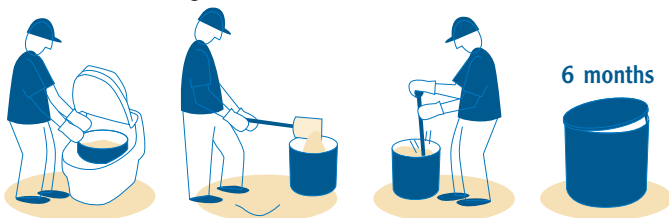

Fertilising

The urine, which contains the greater part of our useful waste, is easily spread on lawns and shrubs. With a Separett Ejectortank, the urine is automatically diluted correctly (about 8 parts water to 1 part urine) in order for plants to absorb the nutrients without damage.

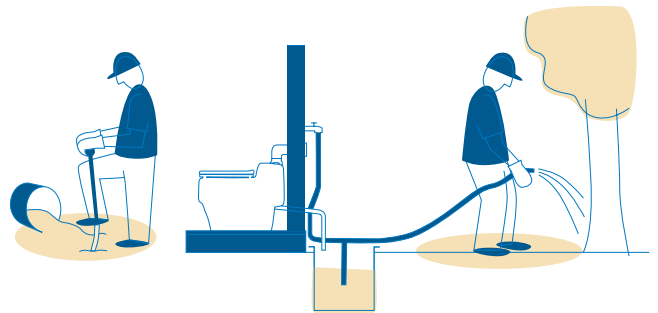

Separett®

Waterless Toilets